

PC2H PRESSURE COMP

**Bidirectional Metered Flow within $\pm 5\%$ ~ 1/4" to 1"
Carbon Steel body for working pressures to 3,000 PSI**



DMIC's **PC2H** acts as a "smart" needle valve, maintaining bidirectional regulated flow within $\pm 5\%$ of the user setting upon inlet and outlet pressure fluctuation.

- DMIC's **ChromaFlow** color-coded design facilitates initial calibration, system documentation, and restoration of correct settings if required
- Designed for **3,000 PSI maximum operating pressure**, can operate at higher working pressure with loss of regulation precision (call DMIC)
- **Optional security knob** (append suffix \backslash LHS') permanently fixes valve flow setting for tamper resistance and "goof-proofing"
- For OEM production quantities, **optional "fine" needle profile** available
- **Quality construction**, premium ergonomics, and superb aesthetics show your system is built to a "quality standard"; not a "price" standard

PC2H	Nominal Size	Port Thread	Performance Data		Dimensions (inches)					
			Minimum Flow GPM (l/m)	Maximum Flow GPM (l/m)	A	B	C	D	E	Lbs. kg
PC2H-0250N	1/4"	1/4" NPTF	0.3 GPM 1 l/m	3 GPM 11 l/m	2.73	1.38	2.97	3.63	0.81	1.0
PC2H-0250B		1/4" BSPP								
PC2H-0375N	3/8"	3/8" NPTF	0.6 GPM 2 l/m	6 GPM 23 l/m	3.15	1.50	3.47	4.16	1.00	1.5
PC2H-0375B		3/8" BSPP								
PC2H-0375S		#6 SAE	0.3 GPM 1 l/m	3 GPM 11 l/m	2.73	1.38	2.97	3.63	0.8	1.0
PC2H-0375IU		16mm ISO6149								
PC2H-0500N	1/2"	1/2" NPTF	1.5 GPM 6 l/m	15 GPM 57 l/m	4.04	1.75	4.06	4.94	1.19	2.6
PC2H-0500B		1/2" BSPP								
PC2H-0500S		#8 SAE	0.6 GPM 2 l/m	6 GPM 23 l/m	3.15	1.50	3.47	4.16	1.00	1.5
PC2H-0500IU		18mm ISO6149								
PC2H-0625S	5/8"	#10 SAE	1.5 GPM 6 l/m	15 GPM 57 l/m	4.04	1.75	4.06	4.94	1.19	2.6
PC2H-0625IU		22mm ISO6149								
PC2H-0750N	3/4"	3/4" NPTF	2.5 GPM 10 l/m	25 GPM 95 l/m	5.06	2.25	4.79	5.88	1.38	5.0
PC2H-0750B		3/4" BSPP								
PC2H-0750S		#12 SAE			5.06	2.25	4.79	5.88	1.38	5.0
PC2H-0750IU		27mm ISO6149								
PC2H-1000N	1"	1" NPTF	5 GPM 19 l/m	50 GPM 190 l/m	6.90	2.75	5.63	6.94	1.88*	10.0
PC2H-1000B		1" BSPP								
PC2H-1000S		#16 SAE			6.90	2.75	5.63	6.94	1.88*	10.0
PC2H-1000IU		33mm ISO6149								

- NOTES: (1) Typical flows quoted in U.S. GPM, using 100 SUS Petroleum Based Fluid at 100°F
 (2) This model incorporates a reverse flow check. For 1-way select model **PC1H**, page 12
 (3) Manifold mount version available for OEM production quantity orders, call DMIC
 (4) For production qty. orders, non-adjustable versions factory preset to Buyer's flow setting are available
 (5) **PC1H** and **PC2H** valves require a minimum pressure differential between the inlet and outlet ports for correct operation. For sizes below 1/2", 107.5 PSI (7 Bar) is required; larger sizes require 159.5 PSI (11 Bar)

(*) Means HEX



PC2H PRESSURE COMP

PC2H	Physical Parameters
VALVE BODY	Carbon Steel
POPPET	Stainless Steel
SEALING	Buna-N Standard
WORKING PSI (1/8" - 3/4")	3000 PSI (207 Bar)
SAFETY FACTOR	Minimum 3:1
RETURN FLOW CHECK	Absent in PC2H
CHECK VALVE SETTING	N/A
TEMP RANGE	-40°F/250°F (-40°C/121°C)

For complete ordering information and option availability please see page 20.

PC 2H - 0500 N /LHS

Model	
1H	Steel, 1-Way Pressure Comp
2H	Steel, 2-Way Pressure Comp

Nominal Size	
Expressed in 1/1000" units	
Example: 0375 = 3/8", 1 1/2 = 1500	

Inlet Port Thread	
Standard US/Canada	
N	NPT
S	SAE ORB
Metric Standard	
B	BSPP
Optional Threads (Call DMIC)	
B	BSPP
T	BSPT
IU	ISO6149

Easy Order Options	
/LHS	Security (Permanent) Locking Knob

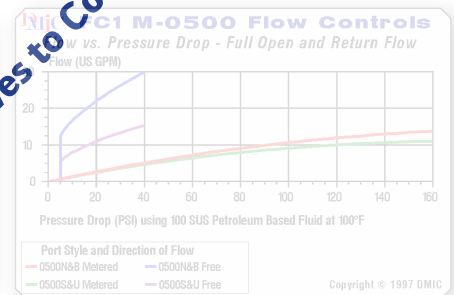
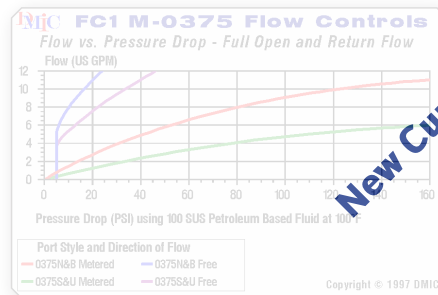
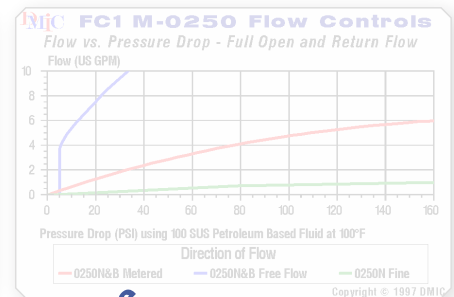
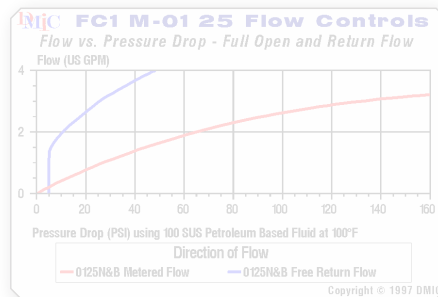
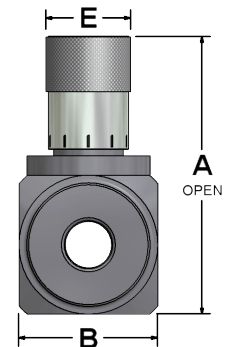
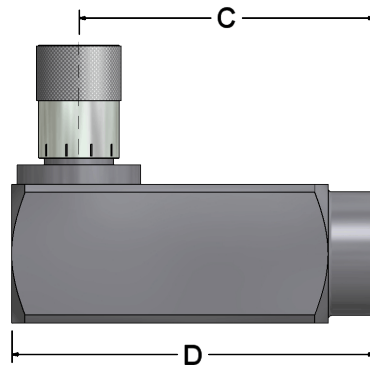

New Curves to Come

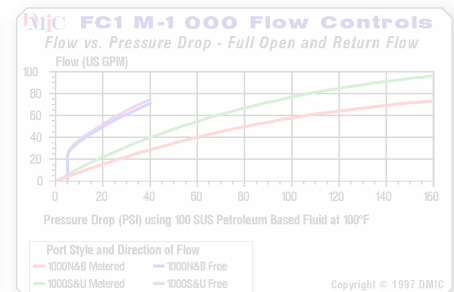
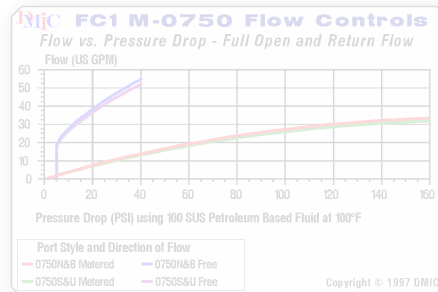
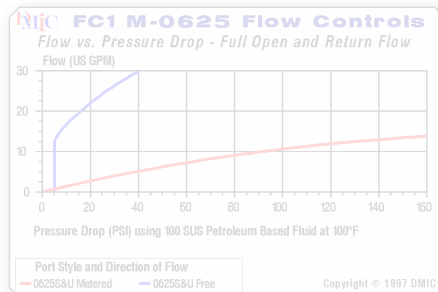

This valve series is factory sealed and disassembly will destroy the valve and void the warranty. Due to our policy of continual product improvement, the specifications in this catalog may change without notice. When designing by spec, please request a certified print.

